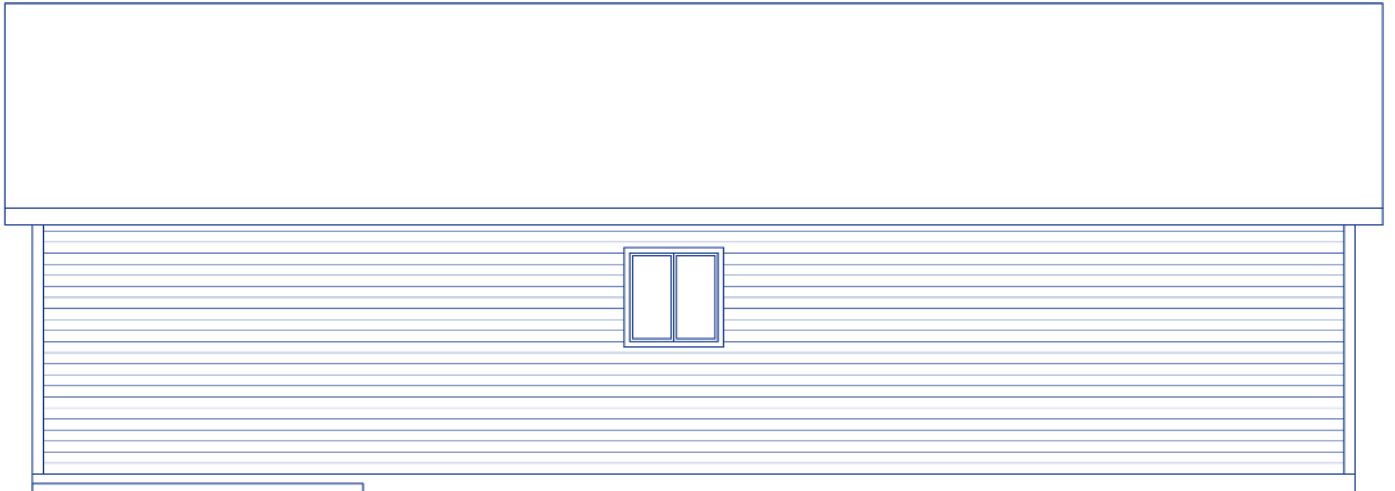

Exhibit B

The Carol (1,120 sq ft) – Front



The Carol – Rear



The Carol – Left

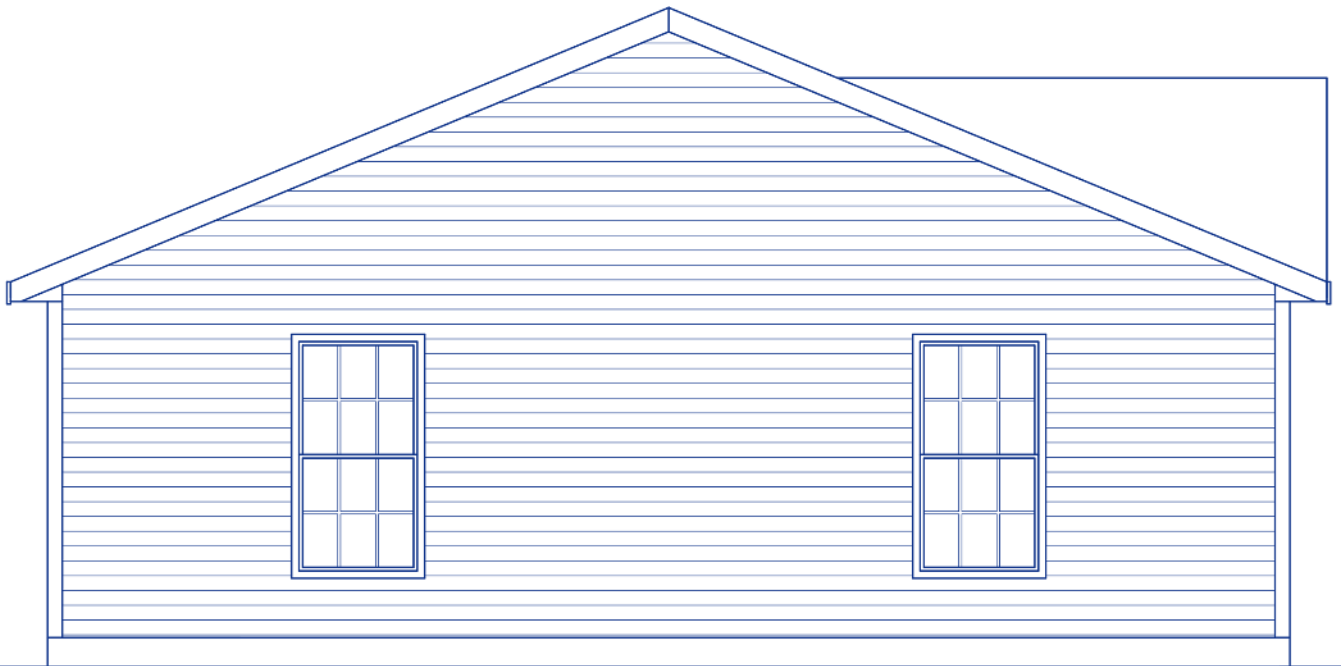

The Carol – Right

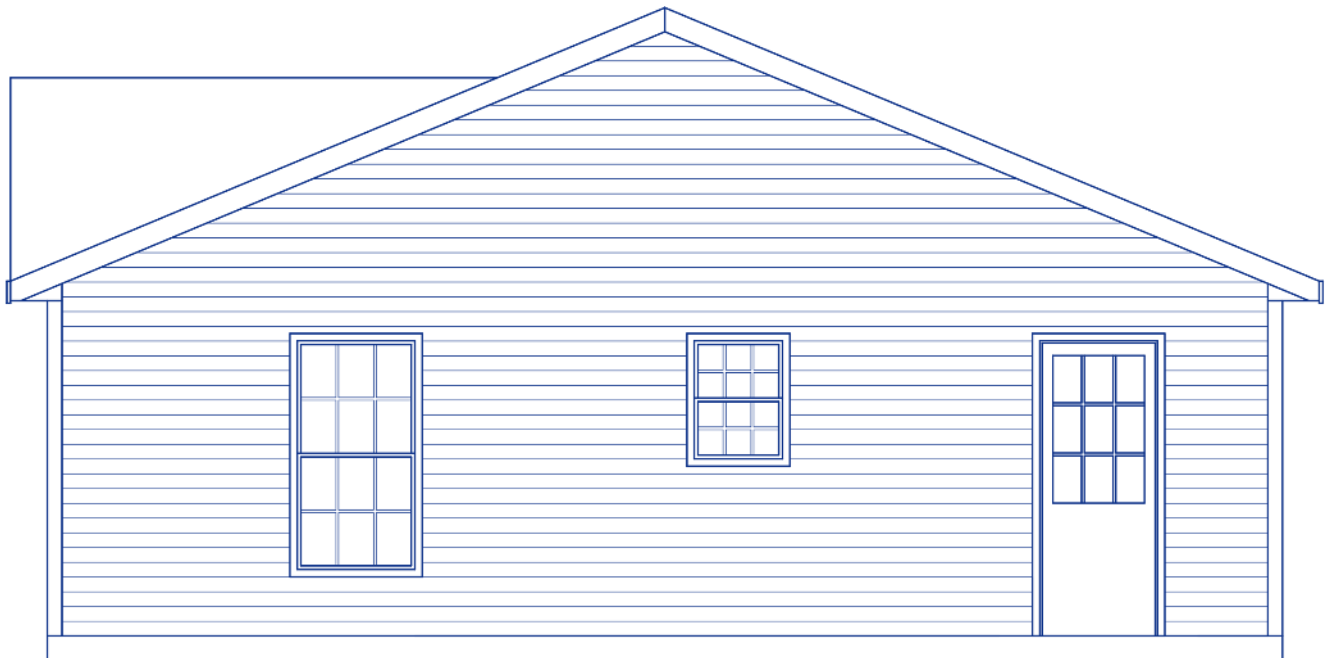

The Carol – First Floor Plan

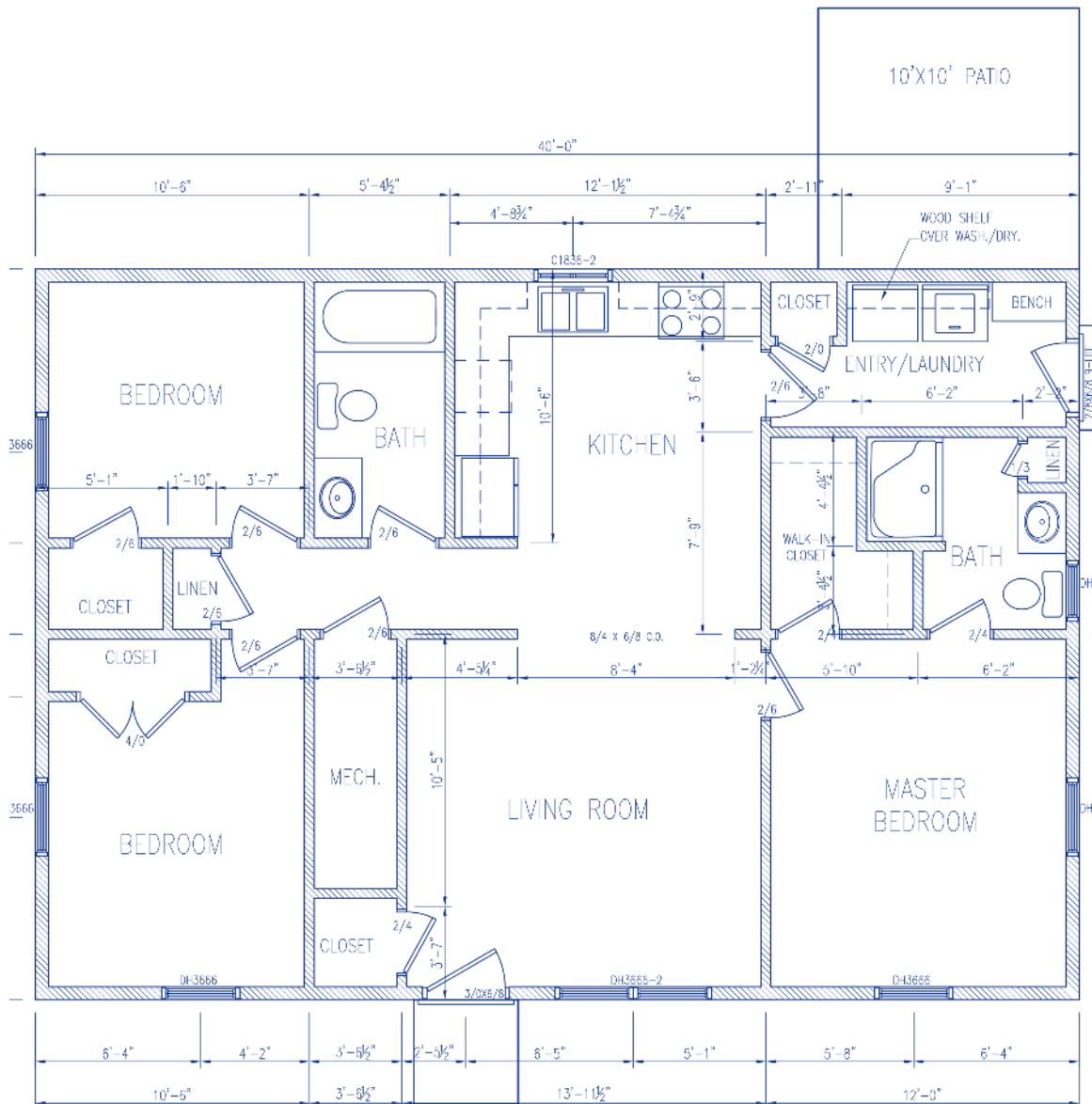

The Carol – Foundation Plan

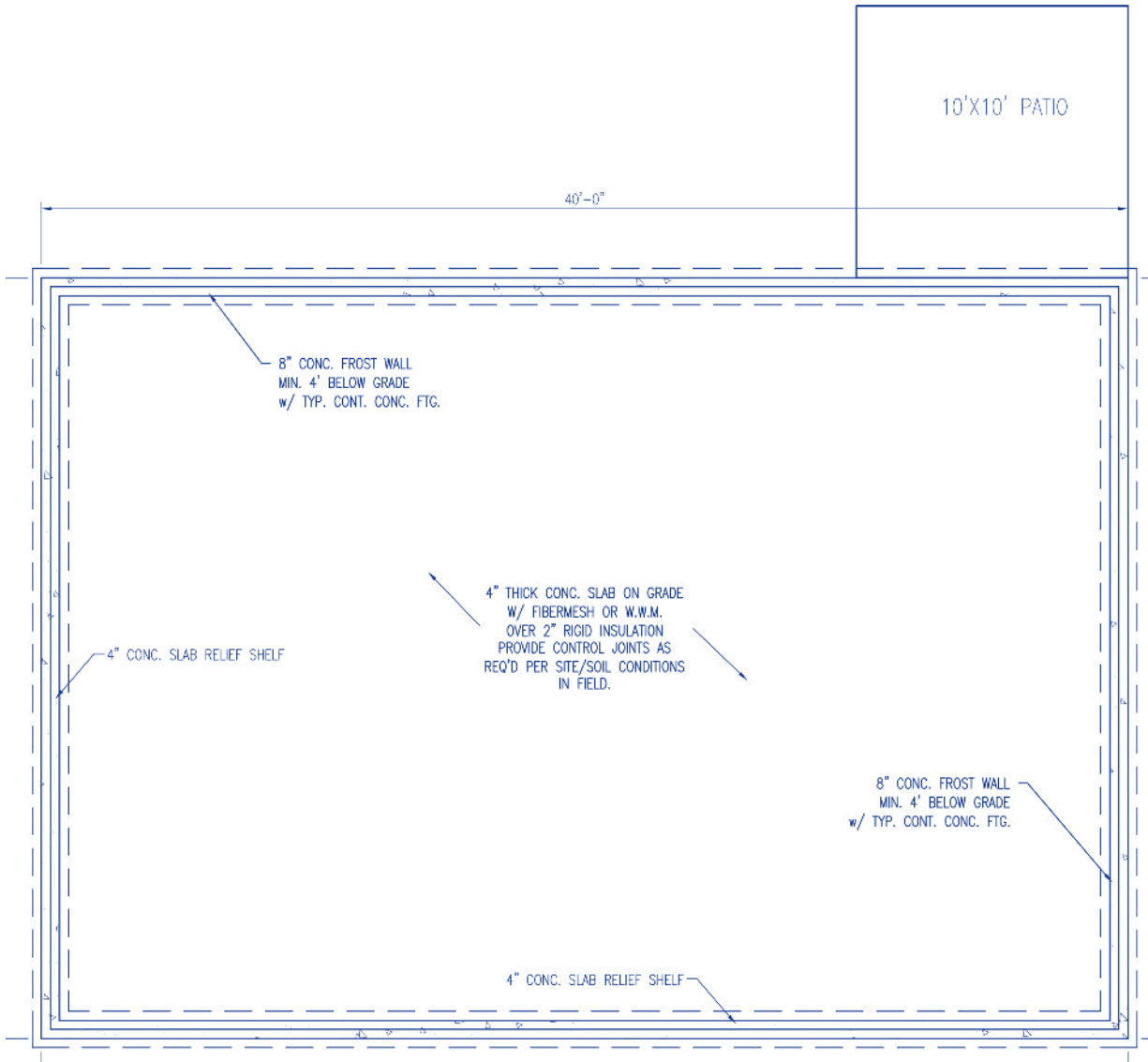

The Carol – Cross-section

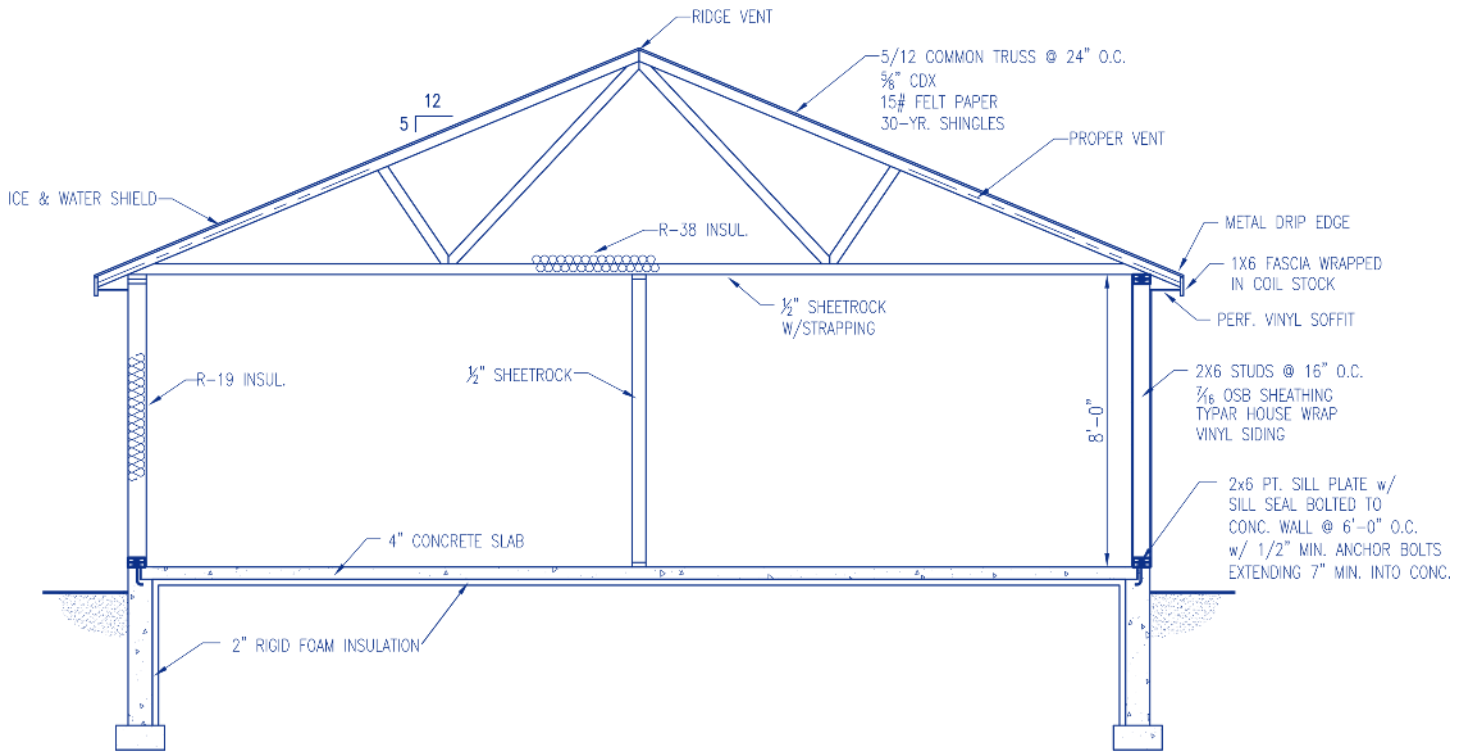

Exhibit C

Kitchen – Perspective 1



Kitchen – Perspective 2



Kitchen – Perspective 3



Master Vanity



Kitchen Plan

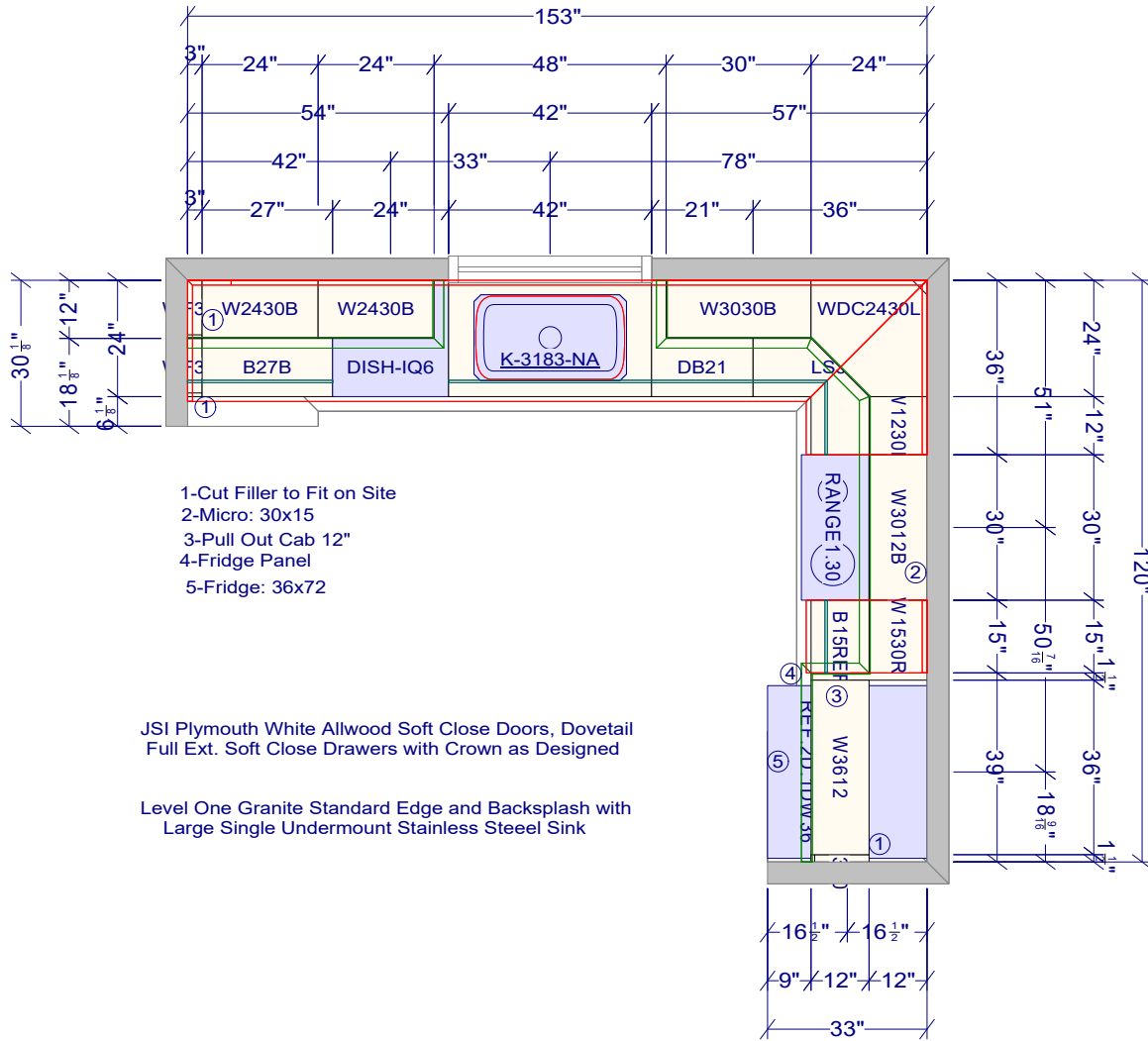

Vanity Plan

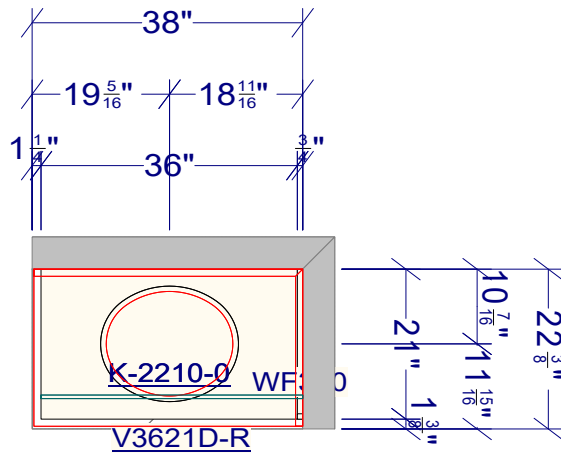

JSI Plymouth White Allwood Doors, Dovetail Drawers
3/4 Ext. Undermount Glides

Level One Granite Standard Edge and Backsplash
with White Oval Sink