

The Abby (2,122 sq ft) – Front

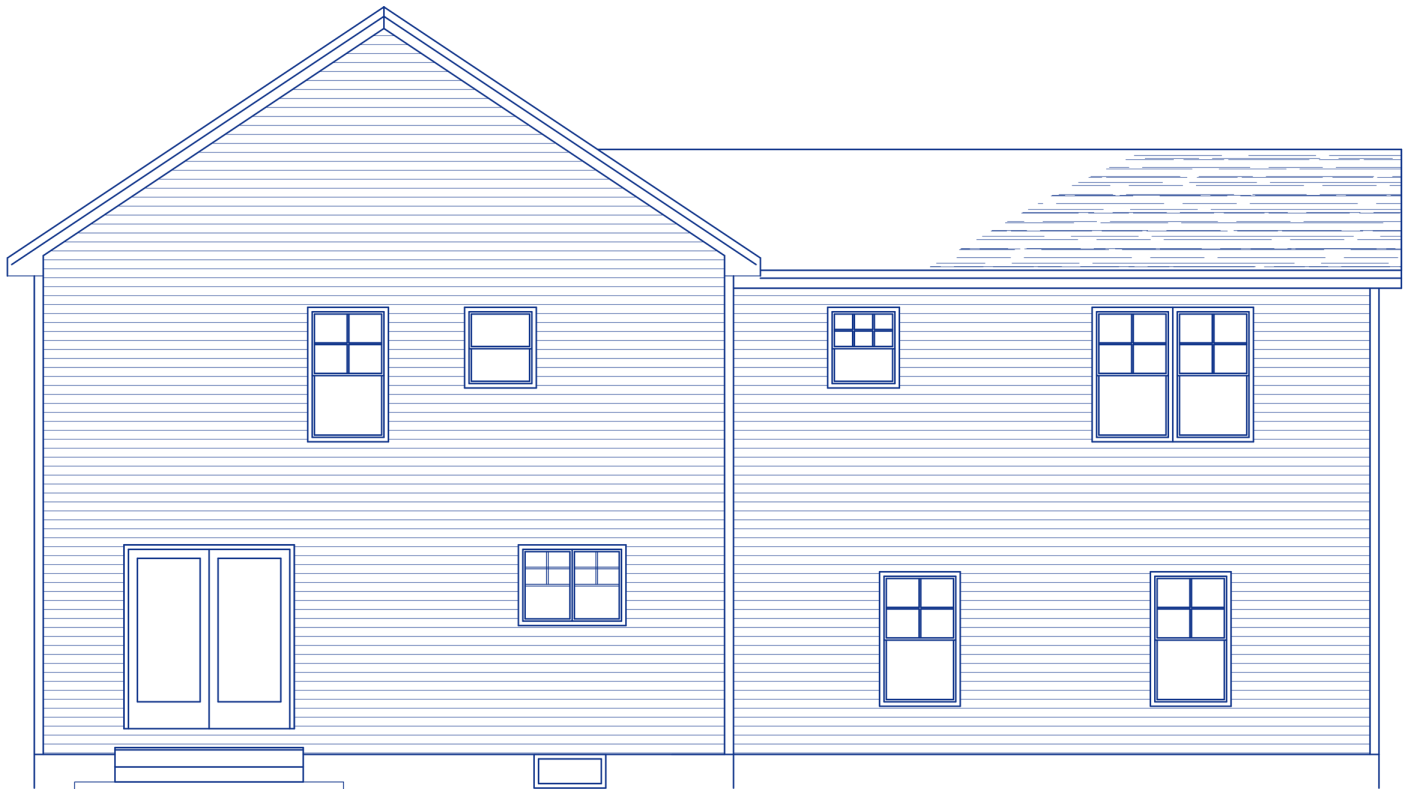

The Abby – Rear



The Abby – Left

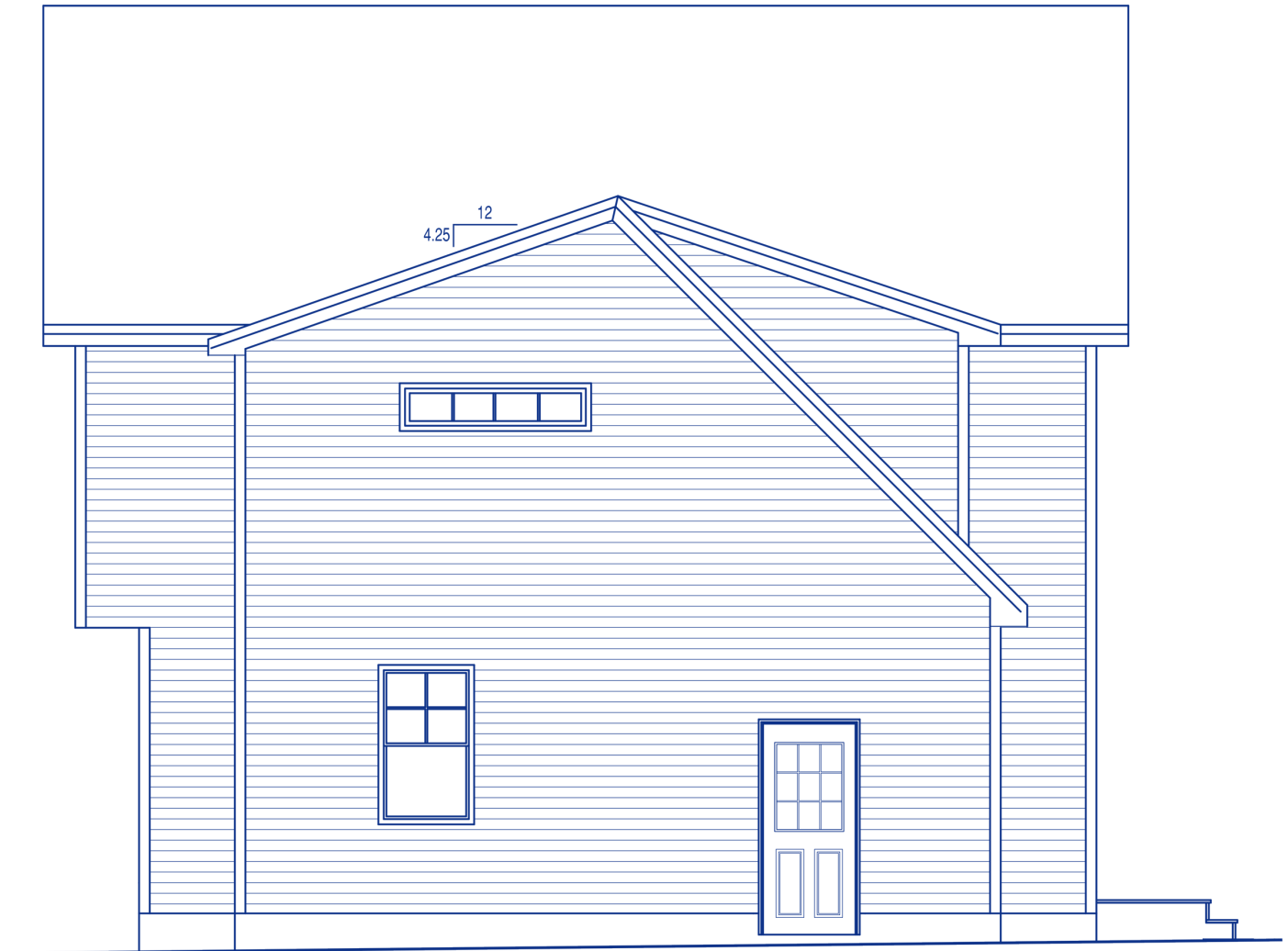

The Abby – Right



The Abby – Cross-section

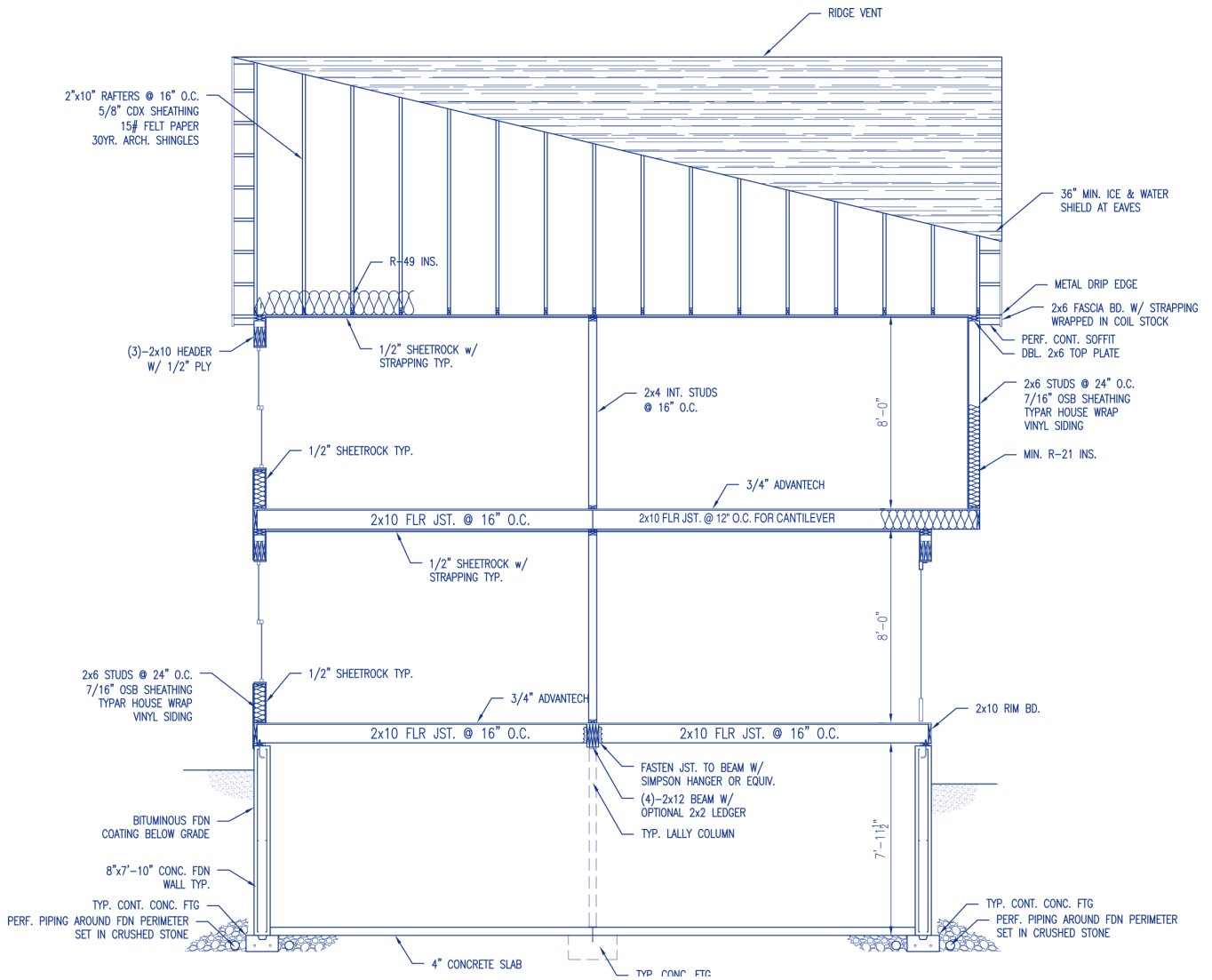

The Abby – Foundation

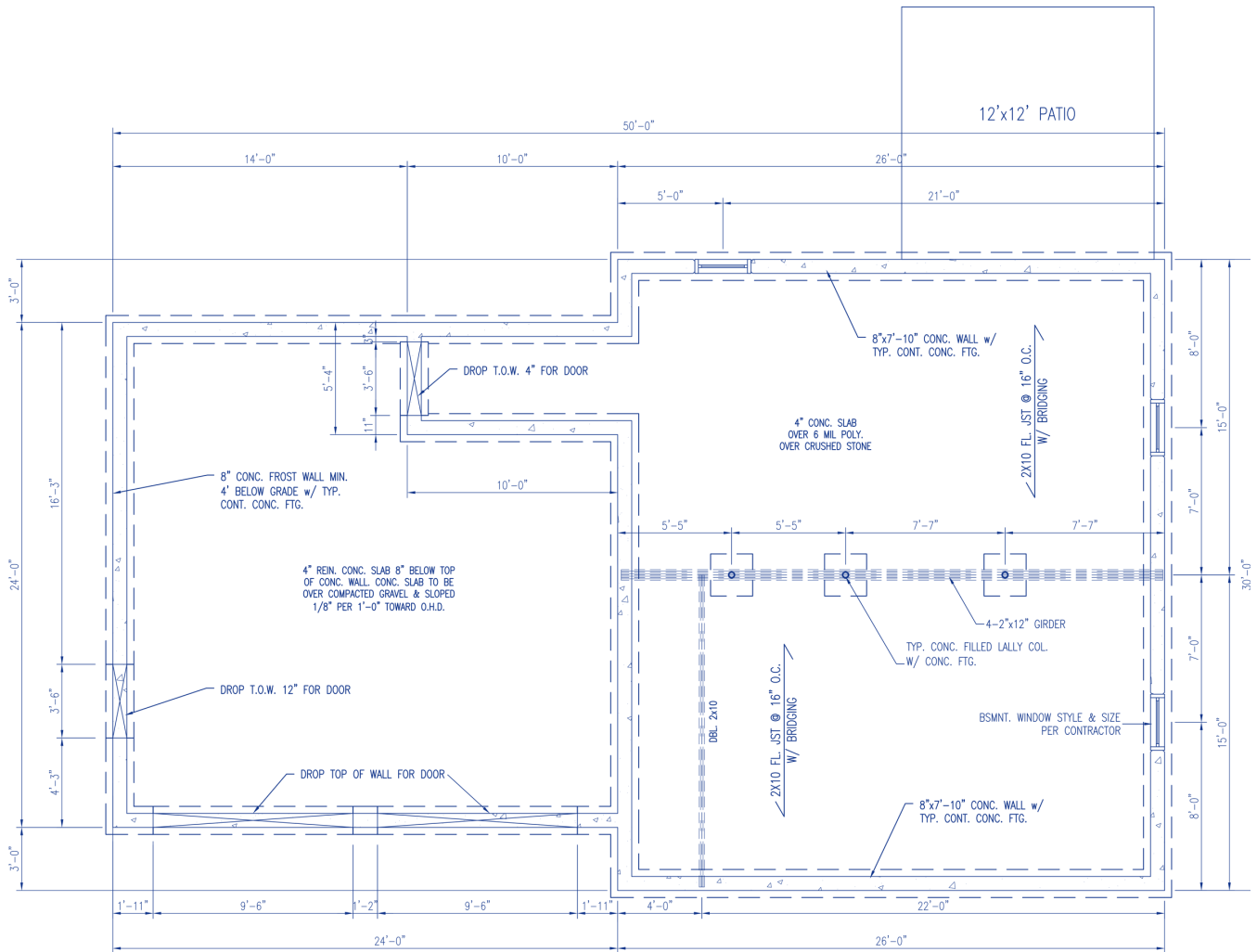

The Abby – First Floor

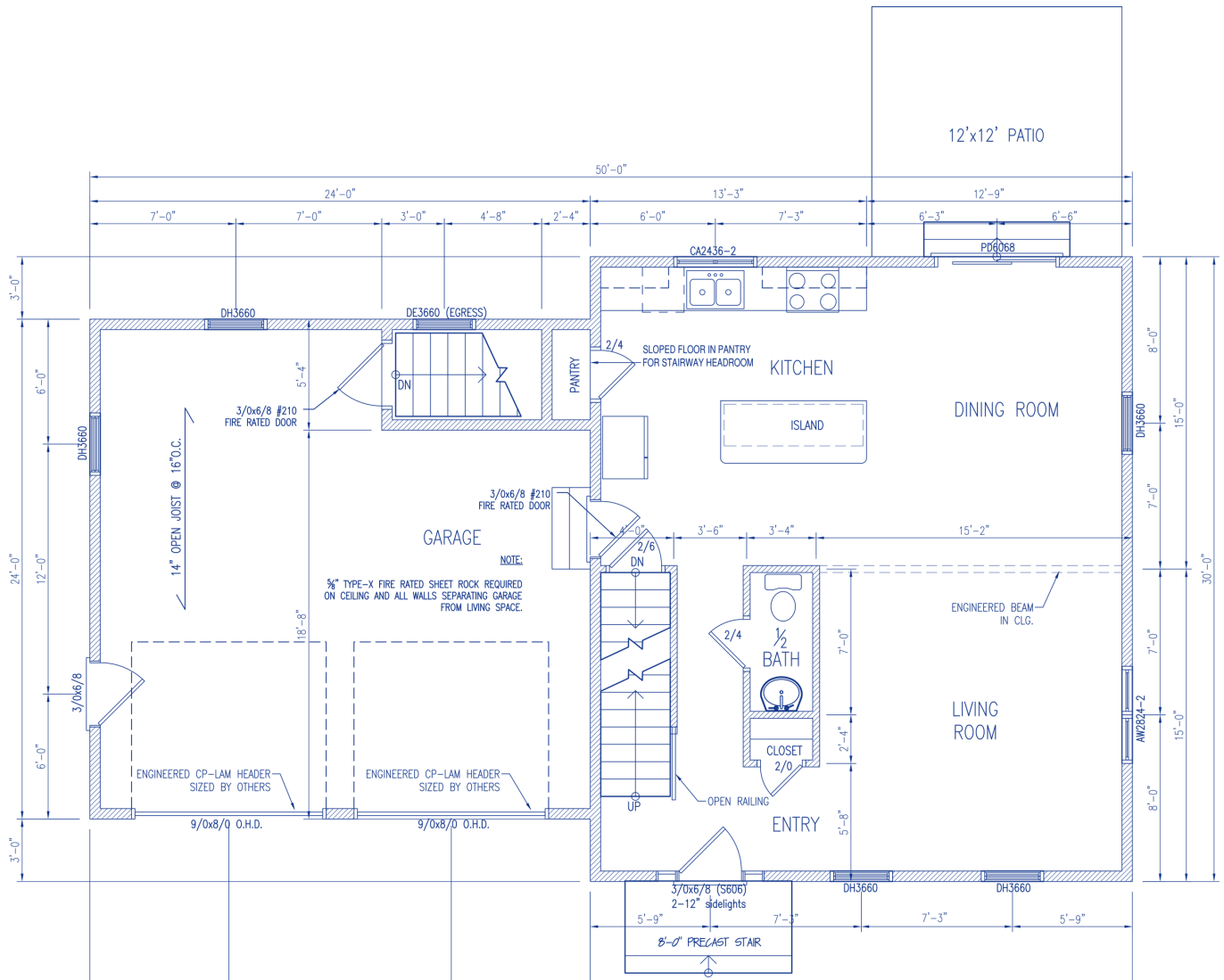

The Abby – Second Floor

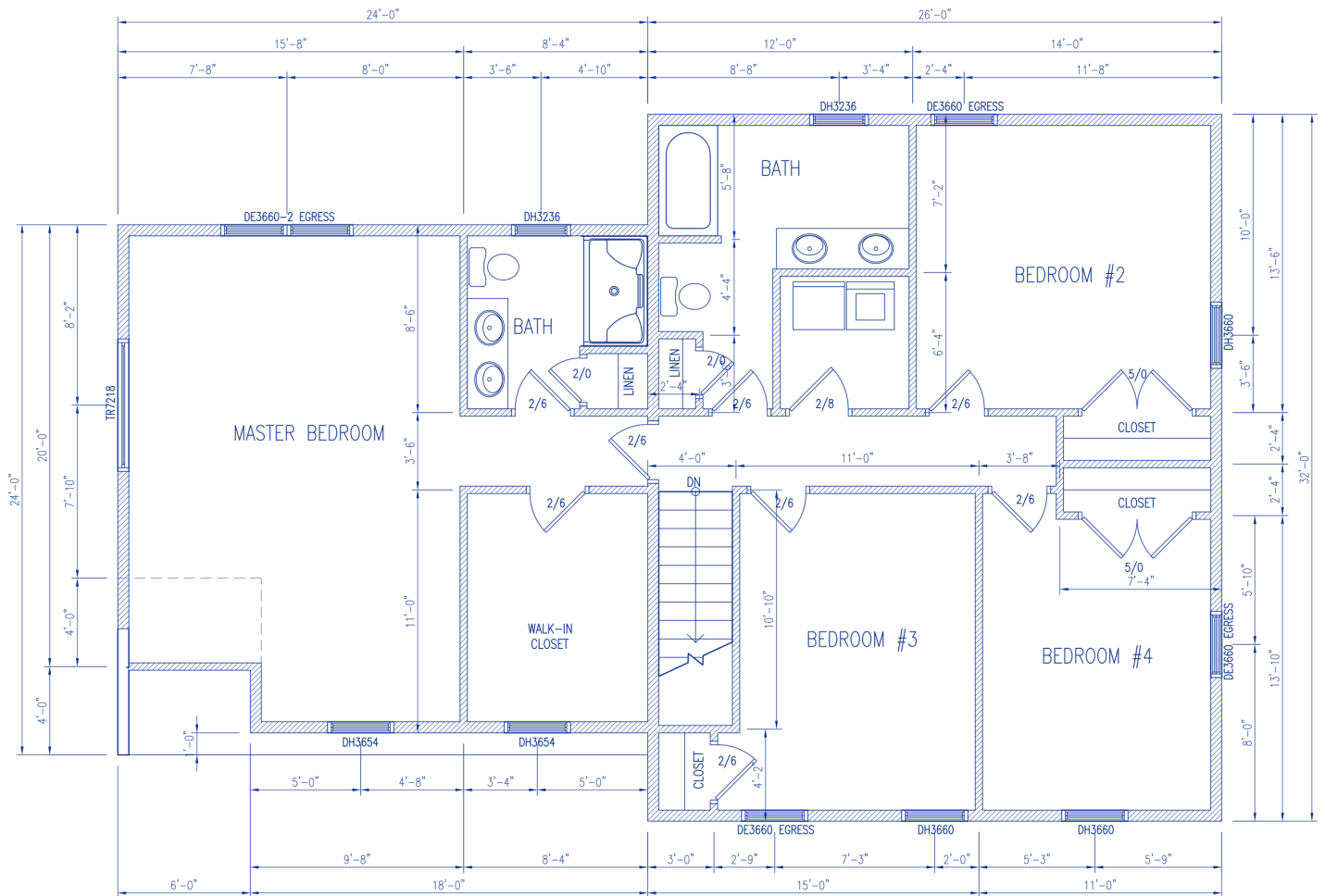

Master Vanity



Guest Vanity



Vanity Plan

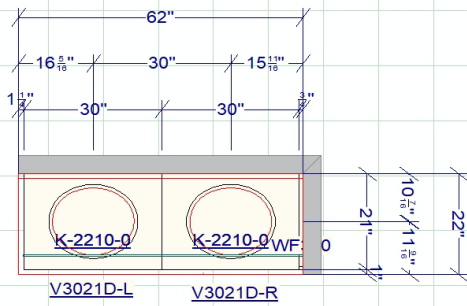

Master

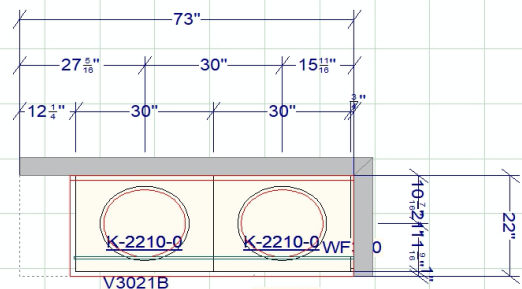

Guest

JSI Plymouth White Allwood Construction Dovetail Full Ext Soft Close Drawers (Master Only) as Designed

Vanity Level One Granite Standard Edge and Backsplsh with White UM Bowls

Approved by: _____

Date: _____